

MB MASTER-BILT[®] Refrigeration Solutions



Installation & Operations Manual for

MB MASTER-BILT[®] BMG PLUS

BMG-HGP & BMG-SLP Model
Bottom Mounted Full-Length Glass Door
Refrigerator Merchandisers

TABLE OF CONTENTS

INTRODUCTION.....	4
STORE CONDITIONS.....	4
WARNING LABELS AND SAFETY INSTRUCTIONS.....	5
PRE-INSTALLATION INSTRUCTIONS.....	6
Inspection for Shipping Damage.....	6
INSTALLATION INSTRUCTIONS.....	6
General Instructions.....	6
Mechanical	6
Electrical.....	7
Temperature Control.....	7
Leg.....	8
Doors.....	8
Grill.....	8
SERVICE INSTRUCTIONS	9
TEMPERATURE CONTROL AND FAN MOTOR REPLACEMENT.....	10
FINAL CHECK LIST.....	10
PARTS LIST.....	11
ACCESSORIES....	11
SALE AND DISPOSAL	12
WIRING DIAGRAM	13-14

INTRODUCTION

This manual contains important instructions for installing, using, and servicing a **BMG-Plus** case. A parts list is included with this manual. Read all these documents carefully before installing or servicing your equipment.

STORE CONDITIONS

The **BMG-Plus** cases are designed to operate in the controlled environment of an air-conditioned store. The store temperature should be at or below 75°F and a relative humidity of 55% or less. At higher temperature or humidity conditions, the performance of these cases may be affected and the capacity diminished.

The **BMG-Plus** should not be positioned where it is directly exposed to rays of sun or near a direct source of radiant heat or airflow. This will adversely affect the case and will result in poor performance.

If this case is to be located against a wall, there should be at least 4" space between the wall and the back of the case. This space will allow for the circulation of air behind the case, which will prevent condensation on the exterior surfaces.



NOTICE

Read this manual before installing your cabinet. Keep the manual and refer to it before doing any service on the equipment. Failure to do so could result in personal injury or damage to the cabinet.



DANGER

Improper or faulty hook-up of electrical components on the refrigeration units can result in severe injury or death.

All electrical wiring hook-ups must be done in accordance with all applicable local, regional or national standards.



NOTICE

Installation and service of the refrigeration and electrical components of the cabinet must be performed by a refrigeration mechanic and/or a licensed electrician.

The portions of this manual covering refrigeration and electrical components contain technical instructions intended only for persons qualified to perform refrigeration and electrical work.

This manual cannot cover every installation, use or service situation. If you need additional information, call or write Customer Service Department.

WARNING LABELS AND SAFETY INSTRUCTIONS



This symbol is the safety-alert symbol. When you see this symbol on your cabinet or in this manual, be alert to the potential for personal injury or damage to your equipment.

Be sure you understand all safety messages and always follow recommended precautions and safe operating practices.



NOTICE TO EMPLOYERS

You must make sure that everyone who installs, uses or services your cabinet is thoroughly familiar with all safety information and procedures.

Important safety information is presented in this section and throughout the manual. The following signal words are used in the warnings and safety messages:

DANGER: Severe injury or death will occur if you ignore the message.

WARNING: Severe injury or death can occur if you ignore the message.

CAUTION: Minor injury or damage to your cabinet can occur if you ignore the message.

NOTICE: This is important installation, operation or service information. If you ignore the message, you may damage your cabinet.

The warning and safety labels shown throughout this manual are placed on your cabinet at the factory. Follow all warning label instructions. If any warning or safety labels become lost or damaged, call your customer service department at (800) 684-8988 for replacements.

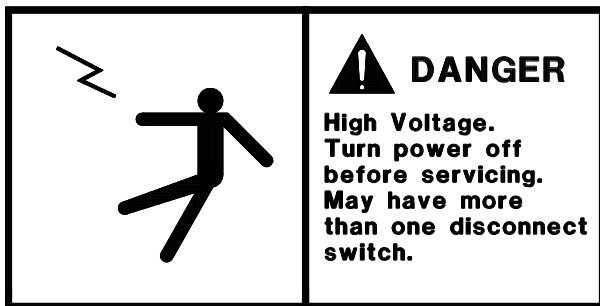

This label is located on top of the electrical control label and on the wiring channel.

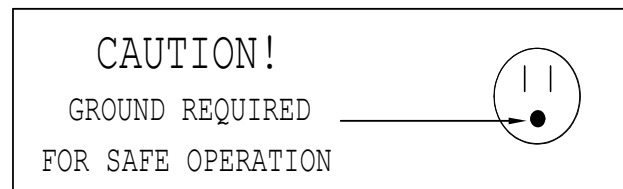

This label is attached to the cabinet power cord on models with a power cord.

PRE-INSTALLATION INSTRUCTIONS

INSPECTION FOR SHIPPING DAMAGE

You are responsible for filing all freight claims with the delivering truck line. Inspect all cartons and crates for damage as soon as they arrive. If damage is noted to shipping crates or cartons or if a shortage is found, note this on the bill of lading (all copies) prior to signing.

If damage is discovered when the cabinet is uncrated, immediately call the delivering truck line and follow up the call with a written report indicating concealed damage to your shipment. Ask for an immediate inspection of your concealed damage item. Crating material must be retained to show the inspector from the truck line.

INSTALLATION INSTRUCTIONS

GENERAL INSTRUCTIONS

1. sure the equipment is properly installed by competent service people.
2. Keep the equipment clean and sanitary so it will meet your local sanitation codes. Clean the cabinet with a mild detergent and water, then rinse.
3. Rotate your stock so that older stock does not accumulate. This is especially important for iccream. A "First-In, First-Out" rotation practice will keep the products in good salable condition.
4. Do not place product in the case when it is soft or partially thawed. Also, product should not be put in the case for at least 6 hours after it is started.
5. Stock cases as quickly as possible, exposing only small quantities to store temperatures for short periods of time.
6. When replacing burned out light bars, be sure that the electrical power to the lighting circuit is turned off.

NOTICE TO STORE OWNERS / MANAGERS

Moisture or liquid around or under the cabinet is a potential slip/fall hazard for persons walking by or working in the general area of the cabinet. Any cabinet malfunction or housekeeping problem that creates a slip/fall hazard around or under the cabinet should be corrected immediately.

If moisture or liquid is observed around or under a Master-Bilt cabinet, an immediate investigation should be made by qualified personnel to determine the source of the moisture or liquid. The investigation should determine if the cabinet is malfunctioning or if there is a drainpipe leaking.

MECHANICAL

Remove front grille and check refrigeration lines to see that they are free (not touching each other or compressor). Spin condenser fan blade to see that it is free.

The compressor is hermetic, it is internally spring mounted and ready to run.

Remove cabinet from crate base and slide into location. Cabinet must be level from side to side and front to back for correct draining of coil pan and for self-closing doors to operate correctly. Allow minimum of 4" between back of cabinet and wall and between top of cabinet and ceiling for proper condensing unit air circulation.

To comply with Sanitation requirements the cabinet must be mounted on legs (6" high min.) or casters or the base must be sealed to the floor (BMG) with an N.S.F. listed silicone sealant.

Hang provided NSF Listed thermometer at front of top shelf unless cabinet provided with electronic control.

ELECTRICAL



WARNING

Before servicing electrical components in the case or the doors or door frames make sure all power to case is off. Always use a qualified technician.

Check voltage and amps drawn to determine proper line and fuse or circuit breaker size. Check power supply for low voltage. If voltage reads "120" with no load, and it drops below "100 or less" when the compressor tries to start, it is an indication of too small supply wiring or too long to run.

It is recommended that a separate circuit be run for each cabinet to prevent another appliance blowing the fuse or breaker, causing loss of product.

IMPORTANT

This cabinet is pre-wired internally for 120-volt circuits. "Tapping" or feeding the 115-volt circuit from 230-volt supply may result in overloaded circuit breakers or blown fuses and damage to electrical system, thereby voiding the warranty.

The cabinet should be grounded.

TEMPERATURE CONTROLLER

The cabinet has a temperature control that is adjustable from # 0 (warmest setting) to # 9 (coldest setting). The controller is inaccessible at the venturi inside the cabinet.

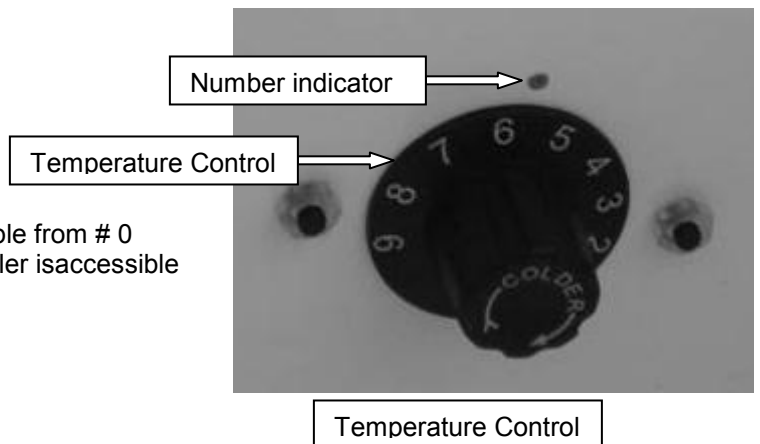

LEG / CASTER INSTALLATION

1. Screw legs / casters tightly into mounting holes under the front and back rail bases.

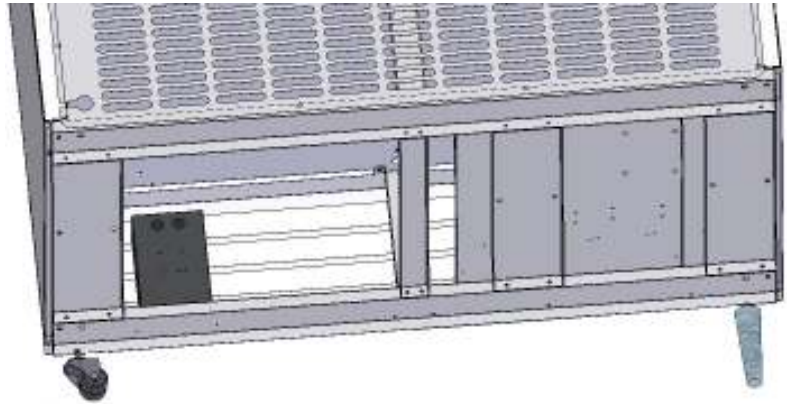

SWING DOORS

The cabinet have Anthony glass doors that are equipped with a patented TorqueMaster™ hinge system. The doors are easily adjusted using a flathead screwdriver (Figure 3).

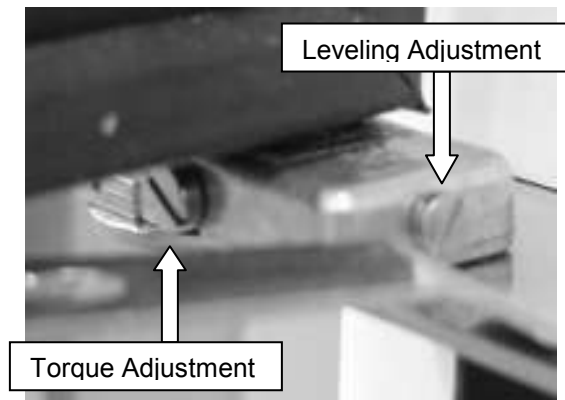
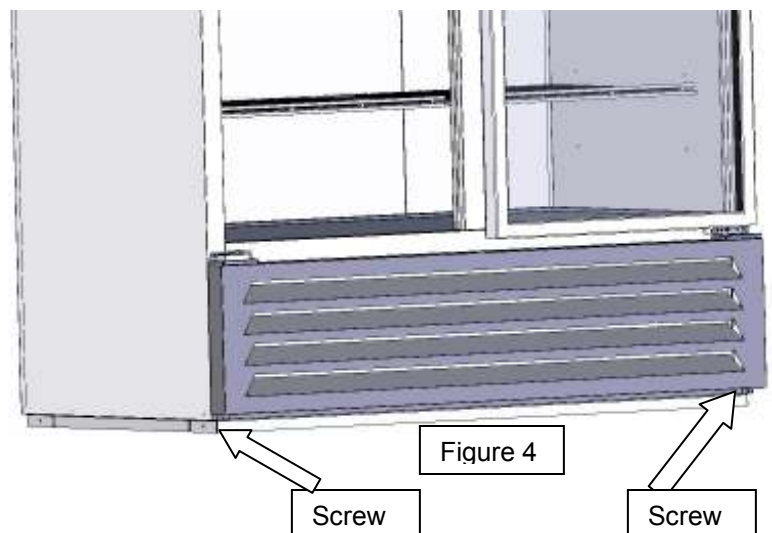

Figure 3

GRILL

To remove bottom grill, unscrew the 2 screws on the bottom for the grill then drop the grill down from the key-slot hole and pull out. (See Figure 4)



SERVICE INSTRUCTIONS

1. High head pressure and high back pressure:
 - A. Condenser coil clogged or restricted
 - B. Condenser fan motor defective.
 - C. Air discharge in rear of cabinet restricted.

2. Low back pressure and low head pressure:
 - A. Restriction in system.
 - B. Refrigerant undercharged.
 - C. Leak in system

3. Pressure normal – cabinet warm:
 - A. Coil blocked with frost (see #4).
 - B. Refrigerant undercharged.
 - C. Control set too warm.

4. Cabinet not cycling – coil blocked with frost:
 - A. Defective temperature controller.
 - B. Refrigerant overcharged.
 - C. Location too hot.
 - D. Condenser clogged.
 - E. Condenser fan motor defective.

5. Compressor starts and runs – but cycles on overload:
 - A. Low voltage
 - B. Relay defective.
 - C. Overload defective.
 - D. High head pressure (see #1).

TEMPERATURE CONTROL AND FAN MOTOR REPLACEMENT

Before making any change, technician should:

1. Disconnect power to the cabinet
2. Remove screws from venturi and pull down

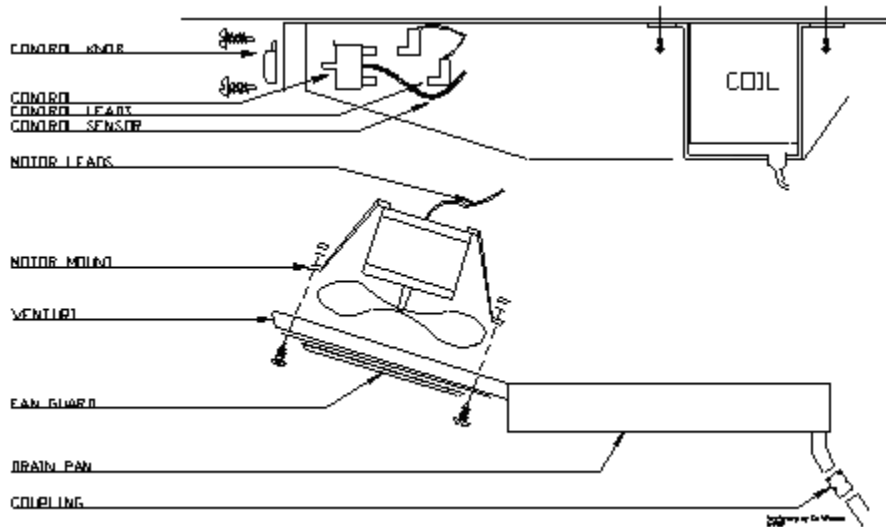

To change fan motor – disconnect fan motor leads – remove screws from fan guards and motor mounts.

To change a temperature control – pull off the control knob and remove screws from the control – unplug the control leads and replace with a new control – put screws back in control and press on control knob.

FINAL CHECK LIST

- A. Check operating pressures.
- B. Check electrical requirements of unit to supply voltage.
- C. Set temperature control for desired temperature range. (**factory recommended @ #6**)
- D. Check sight glass for proper refrigerant charge (**if provided**)
- E. Check condensing unit for vibrating or rubbing tubing. Dampen and clamp as required.

PARTS LIST

Use this chart when ordering replacement parts for your **BMG Plus** cabinets. Always Advise Cabinet Serial Number When Ordering Parts

	BMG-23-HGP	BMG-27-HGP	BMG-48-HGP	BMG-48-SLP	BMG-74-HGP	BMG-74-HGP
LED Light Bar (Single)	23-01835	23-01835	NA	23-01839	23-01835	(2)23-01837
LED Light Bar (Double)	NA	NA	23-01833		23-01833	
Light Switch	23-50793	23-50793	23-50793	23-50793	23-50793	23-50793
Capillary Tube	11-01917	11-01917	11-01919	11-01919	11-01918	11-01918
Evaporator Coil	07-14083	07-14083	07-14086	07-14086	07-14084	07-14084
Evaporator Fan Blade	15-13106	15-13106	15-13106	15-13106	15-13106	15-13106
Evaporator Fan Motor	13-13181	13-13181	13-13181	13-13181	13-13181	13-13181
Evaporator Fan Guard	25-01324	25-01324	25-01324	25-01324	25-01324	25-01324
Compressor	NA	NA	NA	NA	03-15357	03-15357
Condenser Coil	NA	NA	NA	NA	07-14088	07-14088
Condenser Fan Motor	NA	NA	NA	NA	13-13101	13-13101
Condenser Fan Blade	NA	NA	NA	NA	15-13093	15-13093
Condensing Unit	01-01876	01-01876	01-01877	01-01877	NA	NA
Drier	09-09864	09-09864	09-09864	09-09864	09-09864	09-09864
Temperature Control	19-14239	19-14239	19-14239	19-14239	19-14239	19-14239
Thermometer	44-00963	44-00963	44-00963	44-00963	44-00963	44-00963
Door - LH						
Door - RH						
Pilaster	33-01408	33-01408	33-01408	33-01408	33-01408	33-01408
Pilaster Clip	33-01011	33-01011	33-01011	33-01011	33-01011	33-01011
Wall Guard	25-01376	25-01376	25-01376	25-01376	25-01376	25-01376
Shelf (Sides)	33-01812	33-01807	33-01805	33-01805	33-01805	33-01805
Shelf (Middle)	NA	NA	NA	NA	33-01807	33-01807

Accessories

Description	BMG-23, 27-HGP	BMG-48-HGP, SLP	BMG-74-HGP, SLP
Casters (4) 3" Diameter	A200-11140	A200-11140	
Casters (6) 3" Diameter			A212-11140
Legs 6"	A200-11170	A200-11170	A212-11170

SALE AND DISPOSAL

OWNER RESPONSIBILITY

If you sell or give away your cabinet; you must make sure that all safety labels and the Installation - Service Manual are included with it. If you need replacement labels or manuals, factory will provide them free. Contact the customer service department at (800) 684-8988.

The customer service department should be contacted at the time of sale or disposal of your cabinet so records may be kept of its new location

If you sell or give away your cabinet and you evacuate the refrigerant charge before shipment, factory recommends that the refrigerant charge be properly recovered in compliance with section 608 of the Clean Air Act effective November 1995 and in accordance with all applicable local, regional, or national standards.

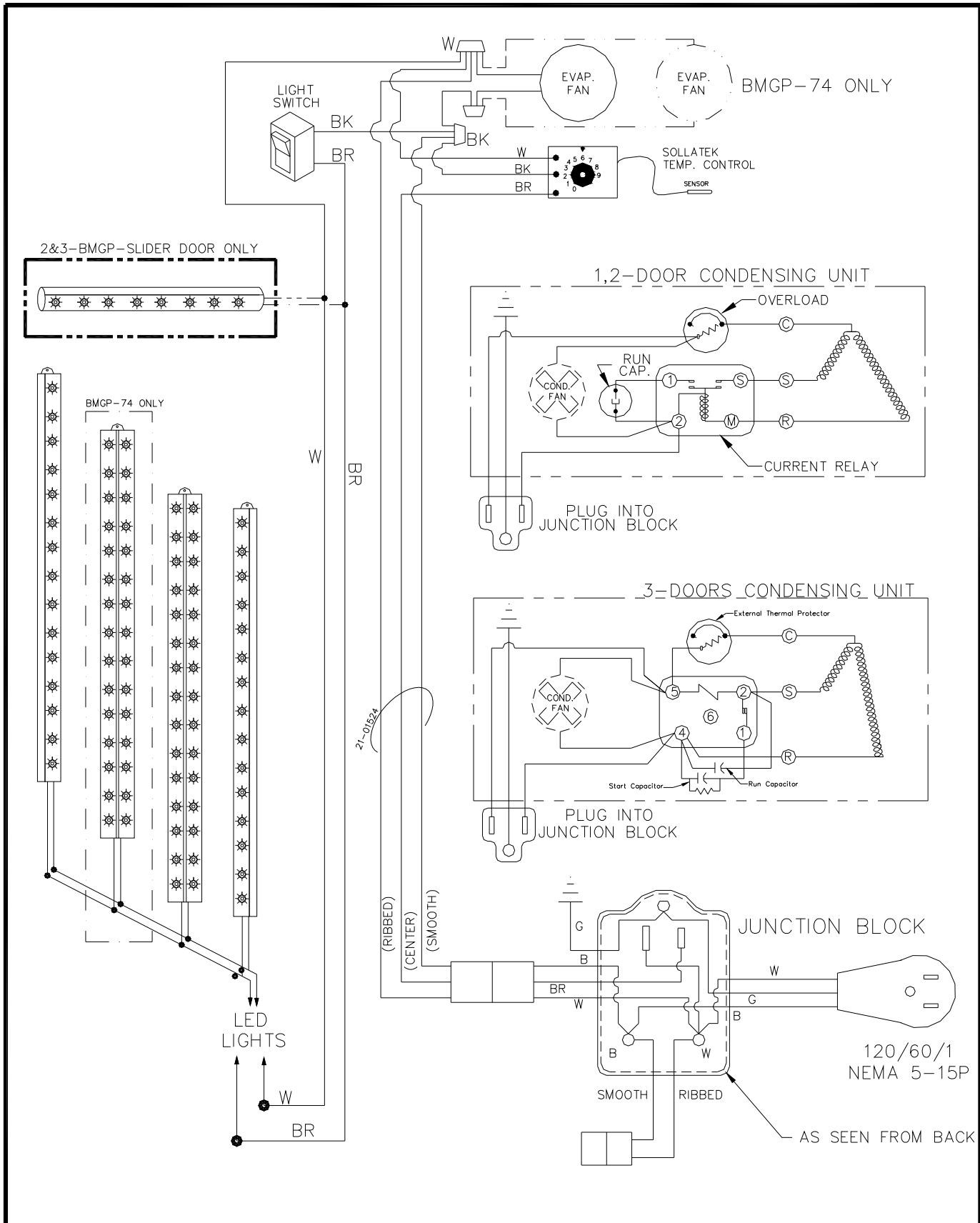

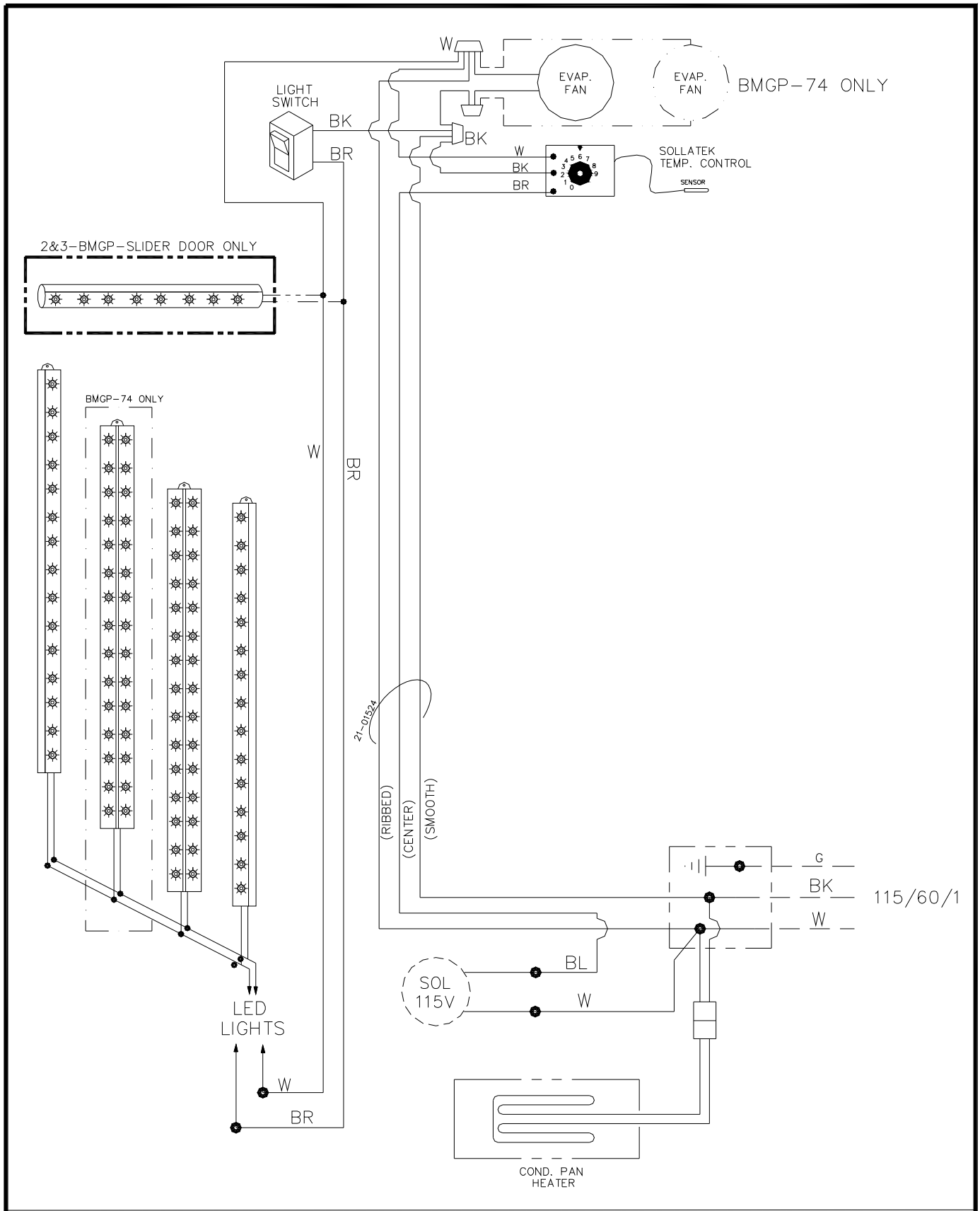



Customer Service/Warranty Parts
Phone: 800-684-8988
Fax: 866-882-7629
Email: service@master-bilt.com